

# Livret de réponses

## Module 1

### Introduction de la CGP

---

graphème « a »

compréhension

Qui sont les personnages de l'histoire ?



Qu'est-ce qu'Arthur et Aïcha achètent ?

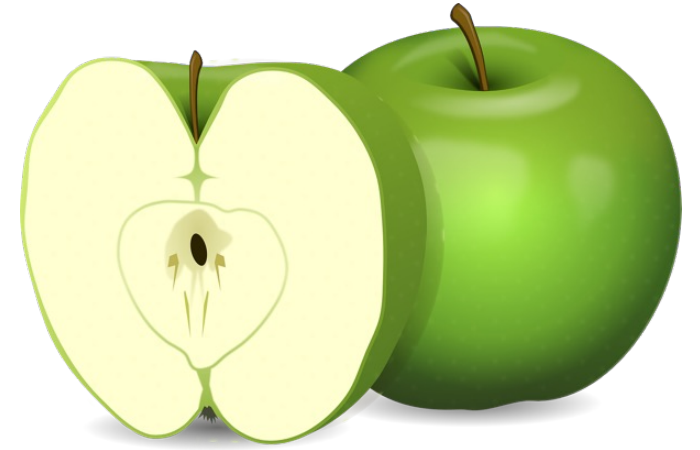
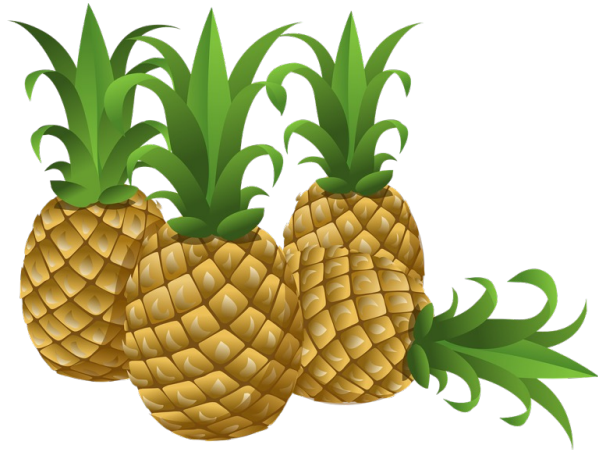
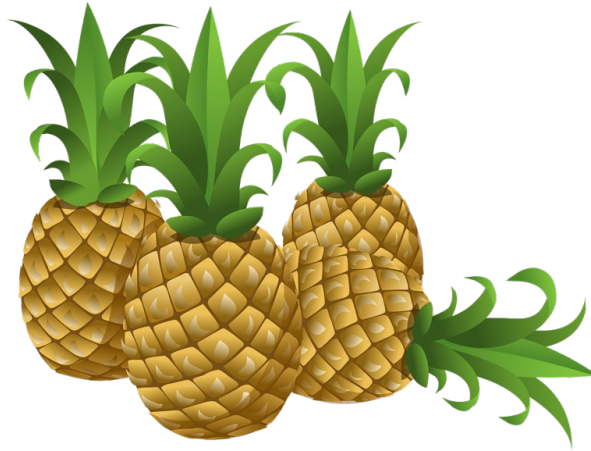
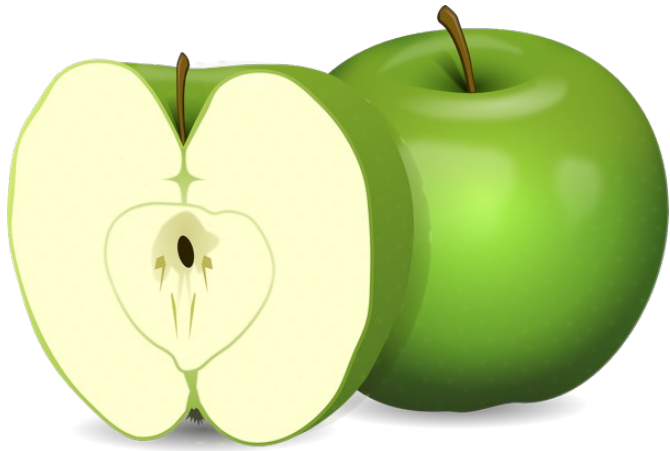

Que font Arthur et Aïcha ?



Pourquoi ils achètent des ananas ?





Qu'est-ce que vous pensez qu'ils vont faire après avoir mangé les ananas ?





graphème « r »  
compréhension

---

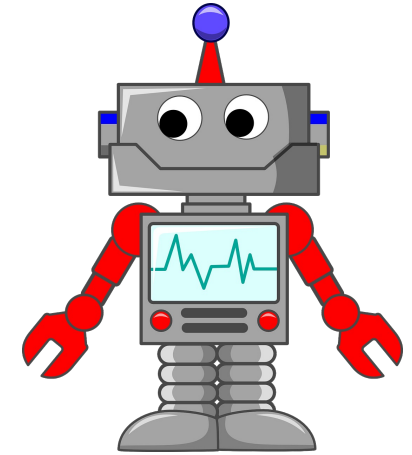
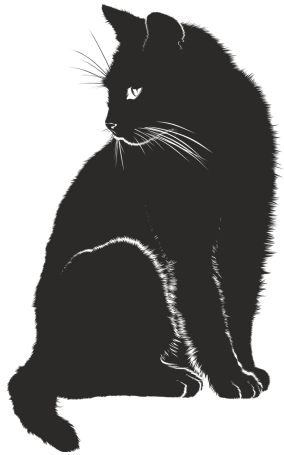

Qui sont les personnages de cette histoire ?

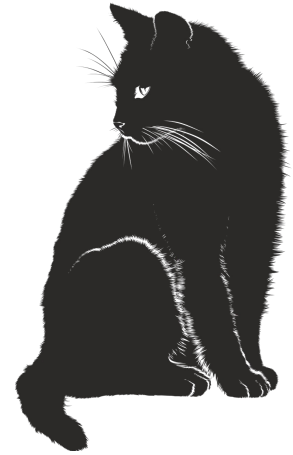
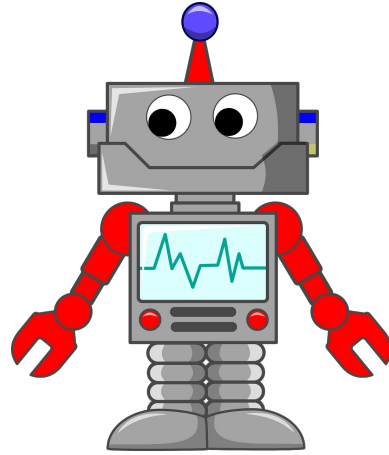
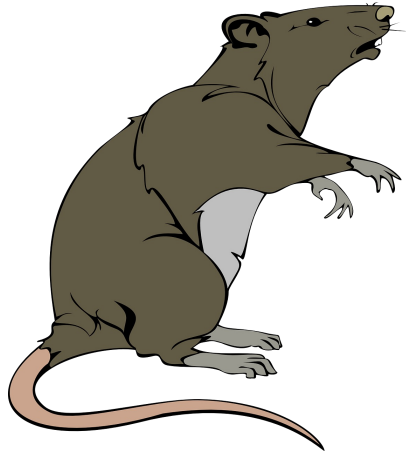

Que fait Ruben dans cette histoire ?





Qu'est-ce que le robot regarde ?



Qu'est-ce que vous pensez qu'il va se passer après ?

# graphème « u »

## compréhension

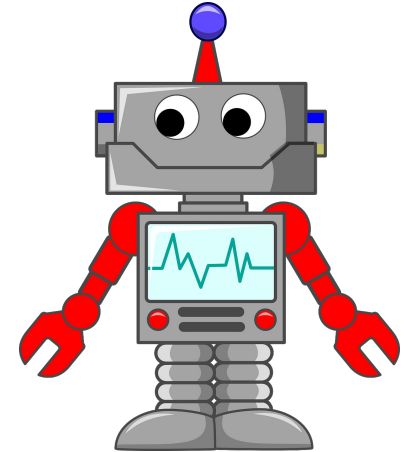

Qui sont les personnages de cette histoire ?

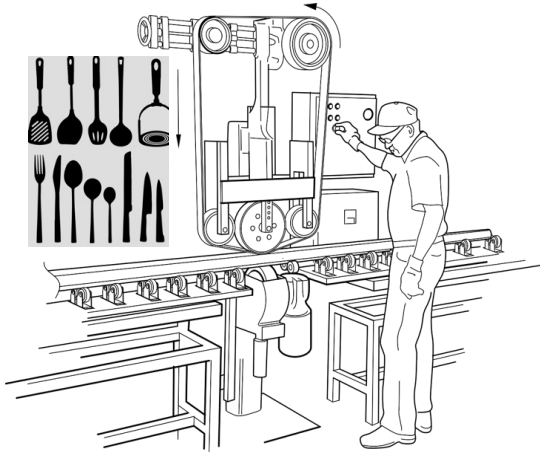
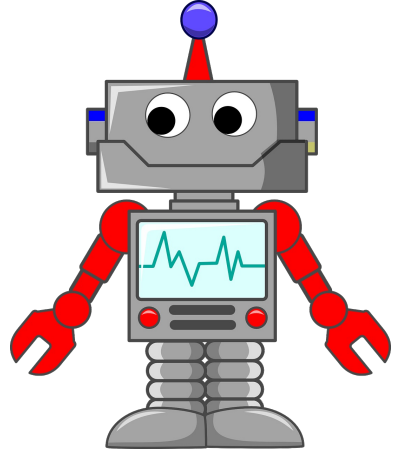

Que fait Ulysse dans cette histoire ?



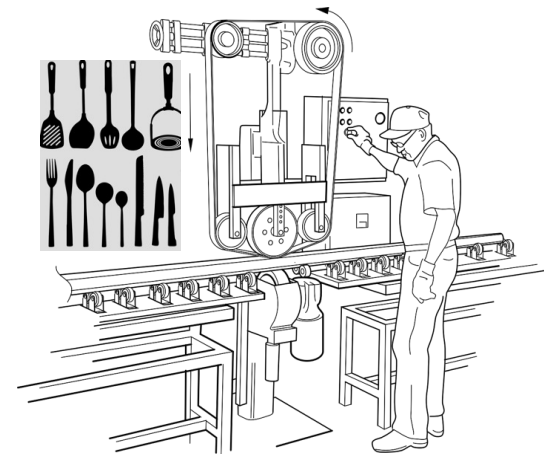

Qu'est-ce qu'il utilise ?



Dans l'histoire on explique qu'Ulysse hurle. Qu'est-ce que vous pensez qu'il s'est passé ?

graphème « i »  
compréhension



Qui sont les personnages de cette histoire ?

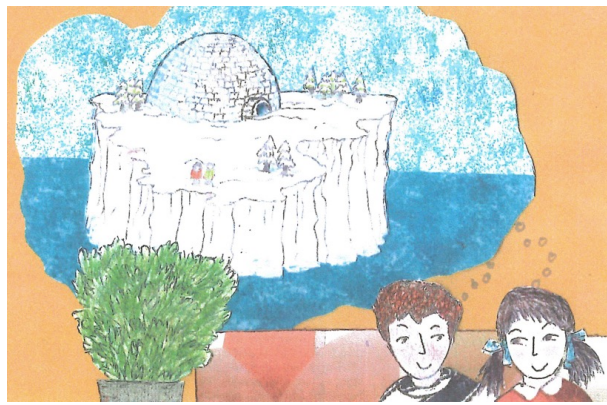
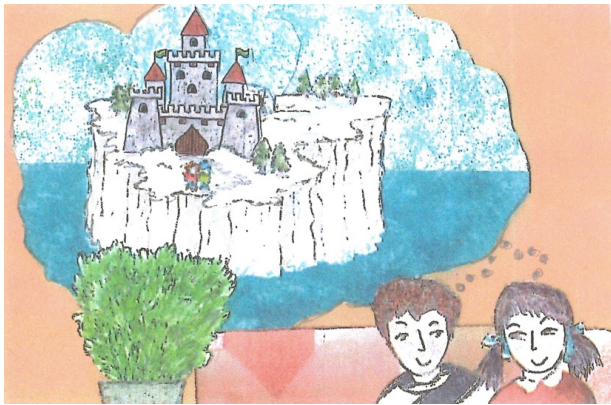

Inès et Igor imaginent vivre où ?



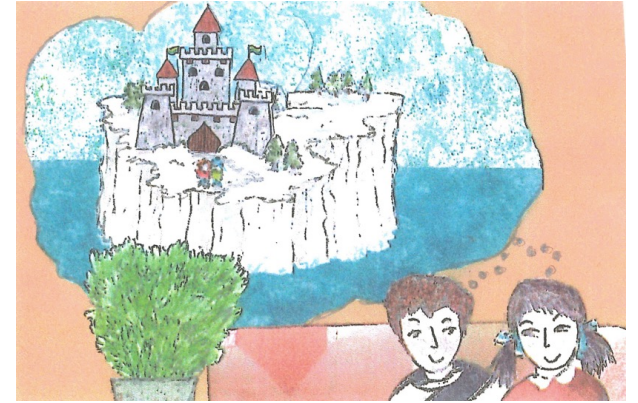
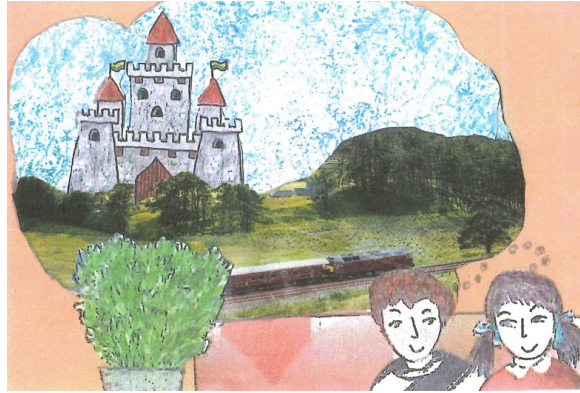

### **Crédits images :**

illustration fille : Nora Sermier

tortue : Clker-Free-Vector © pixabay.com

illustration garçon : Nora Sermier

pomme : OpenClipart-Vectors © pixabay.com

ananas : falco © pixabay.com

banane : OpenClipart-Vectors © pixabay.com

avion au sol : ValeriaRodrigues © pixabay.com

piscine : AgEGlobalGroup © pixabay.com

photographe : Ricinator © pixabay.com

salade de fruits : Pasja1000 pixabay.com

singe : Pfüderi © pixabay.com

femme qui mange un ananas : serezniy © 123RF.com

voiture : Michael\_Luenen © pixabay.com

avion : Leo\_65 © pixabay.com

chat : Gorkhs © pixabay.com

rat : Clker-Free-Vector-Images © pixabay.com

robot : Clker-Free-Vector-Images © pixabay.com

roller : Clker-Free-Vector-Images © pixabay.com

guitare : OpenClipart-Vectors © pixabay.com

jumelles : michaelfuchs60 © pixabay.com

voiture : Alexas\_Fotos © pixabay.com

Vous pensez qu'Inès et Igor vivent où en réalité ?

oiseau : Angeleses © pixabay.com  
symbole roller : Clker-Free-Vector-Images © pixabay.com  
symbole « boom » : OpenClipart-Vectors © pixabay.com  
symbole « attention » : OpenClipart-Vectors © pixabay.com  
illustration personnage usine : Nora Sermier  
marchand : Yolanda © pixabay.com  
usine : Clker-Free-Vecotr-Images © pixabay.com  
ustensiles de cuisine : OpenClipart-Vectors © pixabay.com  
jardinier : GermansLat © pixabay.com  
vétérinaire : Mohamed\_hassan © pixabay.com  
stylo : OpenClipart-Vectors © pixabay.com  
pinceau : mistytableau © pixabay.com

fouet : InspiredImages © pixabay.com  
pansement: Bru-nO © pixabay.com  
casserole : Three-shots © pixabay.com  
pingouin : lisajulie © pixabay.com  
illustration fille : Nora Sermier  
illustration garçon : Nora Sermier  
illustration « château sur une ile » : Nora Sermier  
illustration « igloo sur une ile » : Nora Sermier  
illustration « château » : Nora Sermier  
maison : Pexels © pixabay.com  
château : PIRO4D © pixabay.com  
immeuble : Pexels © pixabay.com

---

